



kayse®

KALİTE FARK YARATIR



SPRINKLER HORTUMU VE BAĞLANTI SETİ
SPRINKLER HOSE AND CONNECTION SET



ÜRÜN TANITIMI

PRODUCT INTRODUCTION

kayse®

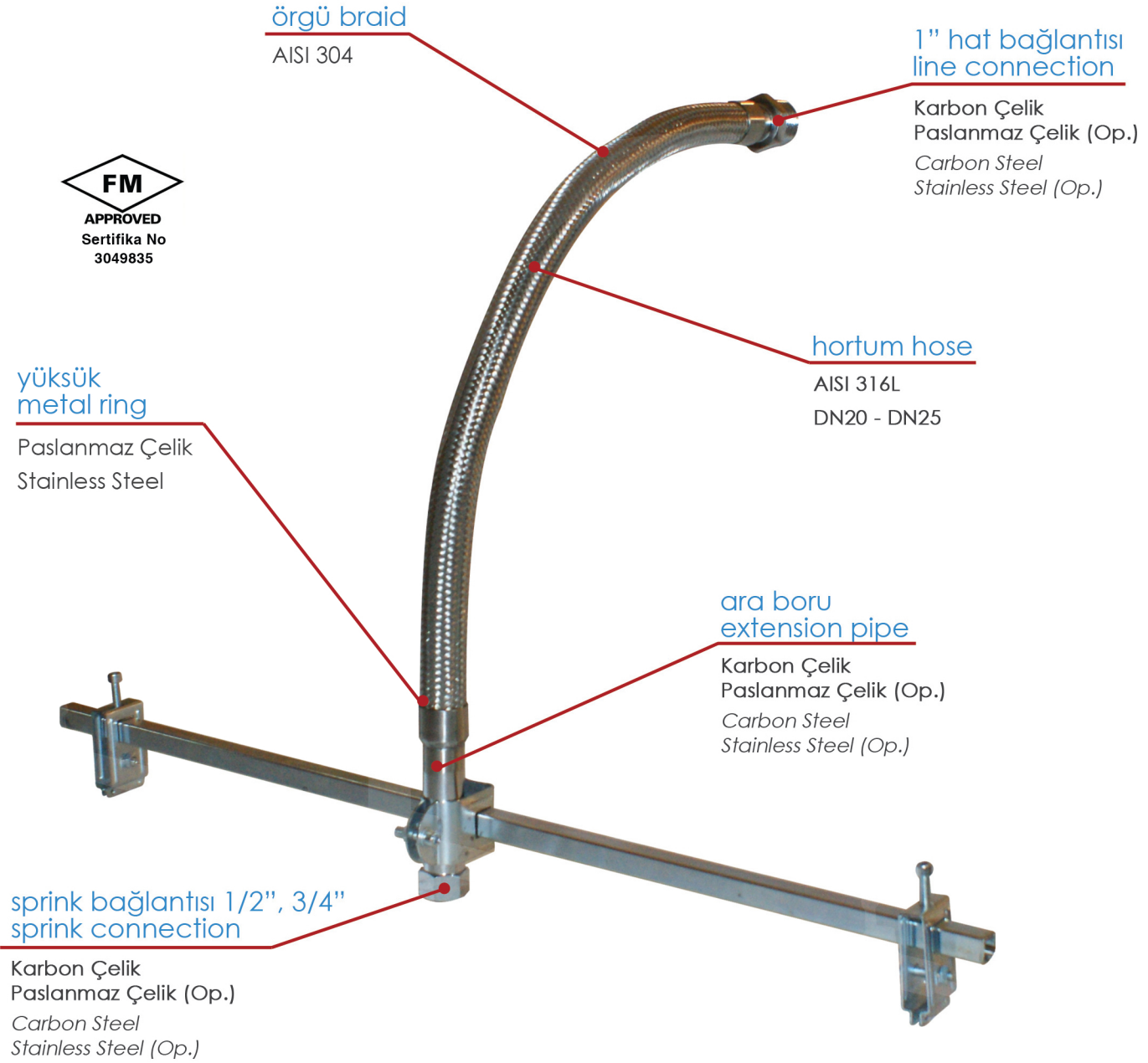

NOMINAL PRESSURE	İŞLETME BASINCI	: 16 bar
TEST PRESSURE	TEST BASINCI	: 25 bar
FLEXIBILITY	ESNEKLİK	: HIGH YÜKSEK
BÜKÜM YARIÇAPI	BEND RADIUS	: 200 mm min.
TEMPERATURE	SICAKLIK	: 200 °C
SPRINK CONNECTION	SPRINK BAĞLANTISI	: 1/2" 3/4" (op.)
LINE CONNECTION	HAT BAĞLANTISI	: 1" NİPPEL NİPEL
APPROVALS	ONAYLAR	: FM

SPRINKLER BAĞLANTI HORTUMLARI

SPRINKLER CONNECTION HOSES

kayse®

GENEL GENERAL

Sprinkler hortumu, yangın hattıyla sprinkler arasındaki bağlantıyı sağlayan, sismik hareketlerden etkilenmeyen flexible örgülü hortumlardır. Özel dizayn bağlantı aparatı yüksek basınçlarda tavana yük gelmeden güvenilir montaj imkanı sağlarken işçilik sürelerini azaltan sistem, zamana bağlı giderleri minimize eder. Kamuya açık alanlarda (hastane, otel, alışveriş merkezleri vb.) tercih edilen sprinkler bağlantı hortumları doğru montaj ile yangın tesisatlarında ömür boyu güvenle kullanılabilir.

Sprinkler hoses; metal, flexible woven hoses that provide the connection between the fire line and the sprinkler which are not effected by seismic movements. Specially designed connection apparatus; they minimize work periods and costs associated with time while enabling safe assembly without putting loads on ceilings at high pressures. The sprinkler connection hoses which are preferred to be used in public areas, tall buildings where fire fighting is difficult and where fire load is high (e.g. hospitals, hotels, shopping malls, etc.) can provide lifelong use in fire installations when installed properly.

KULLANIM ALANLARI AREAS OF APPLICATION

Alışveriş merkezleri,
Otel,ler,
Hastaneler,
Yüksek katlı binalar,
Kamuya açık yapılar,

Shopping Malls,
Hotels,
Hospitals,
Tall buildings,
Public Areas,

AVANTAJLAR ADVANTAGES

Sprinkler Hortumu ve Demir Boru Karşılaştırma Tablosu

Konu	Sprinkler Bağlantı Hortum ve Seti	Demir Boru	Sonuç
Montaj	Günde 80 - 100 Adet/İşçi arası bağlantı yapılabilir	Günde 15 - 20 Adet / İşçi arası bağlantı yapılabilir.	İşçilik maliyeti %75 oranında düşer.
Maliyet	Malzeme maliyeti yüksek, İşçilik ucuz	Malzeme ucuz, İşçilik pahalı.	Yaklaşık maliyet aynıdır.
Titreşim	Flexible yapısı ile titreşimi absorbe eder	Depremde kırılma riski var.	Sistem depremde sorunsuz çalışmaya devam eder.
Dayanım	Ortalama 110 yıl	Ortalama 50 yıl	Paslanmaz ve demirin korozyon dayanımı hesabı yapıp teorik olarak hesaplanmıştır.
Korozyon	AISI 316L	St 37.2	Sprinkler hortumu ile mükemmel korozyon dayanımı
Test	'0' kaçak ile işletme testi yapılabilir.	Test esnasında dirsek noktalarında kaçak olabilir.	Sorunsuz çalışma

Comparison Table for Sprinkler Hose and Iron Pipe

Subject	Sprinkler Connection Hose and Set	Iron Pipe	Result
Mounting	Connections between 80 - 100 Piece/Worker are possible.	Connections between 15 - 20 Piece/Worker are possible.	The labor cost decreases by 75%.
Cost	The material cost is high, the labor cost is low.	The material cost is low, the labor cost is high.	The approximate cost is same.
Vibration	It absorbs the vibration with its flexible structure.	It has break-off risk during an earthquake.	The system continues to work smoothly during an earthquake.
Resistance	110 years on average.	50 years on average.	It has been calculated theoretically by calculating the corrosion resistance.
Corrosion	AISI 316L	St 37.2	Excellent corrosion resistance with the sprinkler hose.
Test	It is possible to make operating test with '0' leakages.	There might be leakages from the elbow points during the test.	Trouble-free working

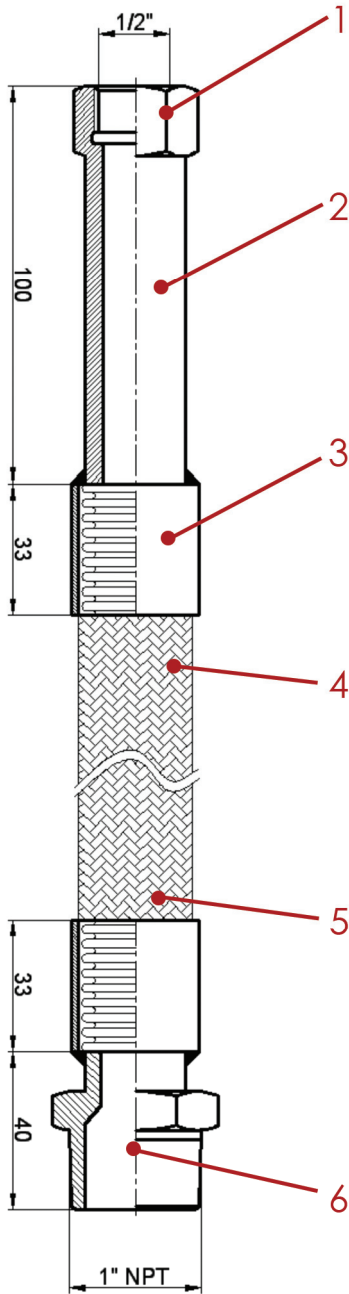

Parça No Part Number	Özellikler Properties	
	Parça Adı Part Name	Malzeme Material
1	Sprinkler Ucu (1/2") Sprinkler Connection (1/2")	St 37.2 AISI 304 - AISI 316 (Op.)
2	Ara Boru Extension Pipe	St 37.2 AISI 304 - AISI 316 (Op.)
3	Yüksük Metal Ring of Braid	AISI 304
4	Örgü Braid	AISI 304
5	Hortum Hose	AISI 316L
6	Yangın Hat Bağlantısı (1") Fire Line Connection (1")	St 37.2 AISI 304 - AISI 316 (Op.)

(Op.) = Opsiyonel *Optional*

Özellikler Properties	Modeller Properties	
		Spr 20
Hortum Çapı Hose Size	DN 20	DN 25
Sprinkler Çapı Sprinkler Size	1/2", 3/4"	
Yangın Hat Bağlantısı Fire Line Connection	1"	
Standart Boylar Standart Lengths	500 mm, 600 mm, 700 mm, 1000 mm, 1200 mm, 1500 mm, 1800 mm, 2100 mm, 2300 mm, 2500 mm,	

Farklı uygulamalar için satış servisimize danışabilirsiniz.
You may contact our sales service for different applications.

Bağlantı Seti Özellikleri Properties of Connection Set

- Malzeme Material : Galveniz Kaplı DKP Sac
: Galvanized DKP Metal Sheet,
Set İçeriği Set Content : 2 Adet Yan Destek Kelepçesi
: 2 Pieces Side Support Clamps,
: 1 Adet Hortum Sabitleme Kelepçesi
: 1 Piece Hose Fixing Clamp,
: 1 Adet Tavan Askı Profili
: 1 Piece Ceiling Suspension Rod,
: 1 Takım Bağlantı Civata ve Somunları
: 1 Set of Connection Bolts and Nuts.

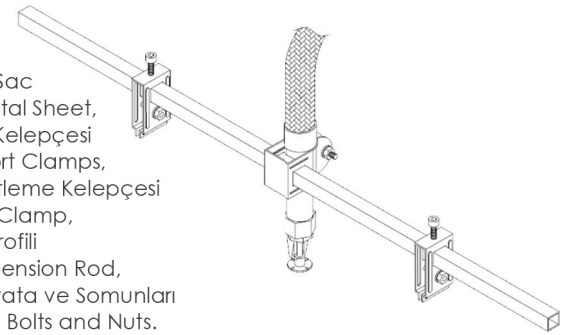

Tavan Askı Profili standart 70 cm' dir. Farklı tavan uygulamaları için Satış Servisimize danışınız.
Ceiling Suspension Rod is standart 70 cm. You may contact our sales service for different ceiling applications.

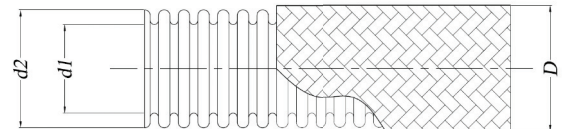

FİTTİNGS DETAYLARI

FITTINGS DETAILS

Modeller Models	Ölçüler Dimensions		Ölçüler Dimensions			Büküm Yarıçapı Bend Radius		Basınç Pressure (20 °C - bar)	Ağırlık Weight (kg/m)
			d1 (mm)	d2 / D (mm)	Tolerans (mm) Tolerance	Statik Static	Dinamik Dynamic		
Spr 20	DN 20	3/4"	20,5	26,7 / 28	± 0,3	70	169	56	0,420
Spr 25	DN 25	1"	25,4	31,8 / 33,7	± 0,3	85	190	64	0,670

BAĞLANTI SETİ DETAYLARI

DETAILS OF CONNECTION SET

kayse®

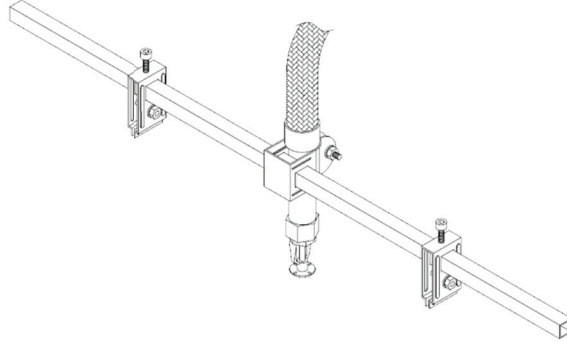

YAN DESTEKLER

SIDE SUPPORT

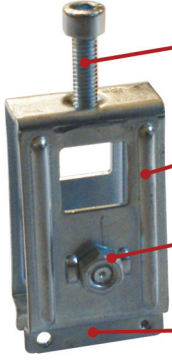

İmbus civata ile daha hızlı ve kolay montaj imkanı.
It enables to mount more quickly and easily with the imbus bolt.

Dışa doğru ve destek boyunca sürekli federler ile daha rijit bağlantı.
Connect more rigidly with the outward continuous feeders along the support.

Yan destek üzerindeki tırnaklar ikinci bir anahtar ihtiyacına gerek kalmadan tavanda hızlı, güvenilir, kolay montaj imkanı sağlar.
The tabs on the side support enable to mount on the ceiling quickly, safely and easily without a need for wrench

Temas yüzeyi artırılmış yan destek kulakları ile yüksek bağlantı mukavemeti.
The strength of the connection has been provided by increasing the contact surface on the metal profile with the side support flaps.

ORTA KELEPÇE

CENTRAL CLAMPS

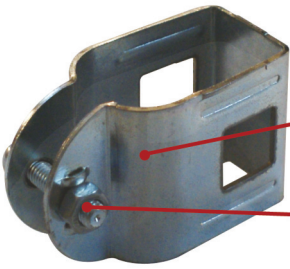

Sprinkler hortumu çapında dizayn edilmiş radyüsler ani verilen basınçlarda sistemin rijit bir şekilde kalmasını sağlar.
The radiuses designed in the diameter of the sprinkler hose enable the system to remain rigid in the pressures released suddenly.

Orta kelepçe üzerindeki tek civata tavanda montaj kolaylığı sağlar. İşlemin allen anahtarı ile yapılması montaj hızını artırır.
The single bolt on the central clamps allows easy mounting on ceiling, and performing the process with a single Allen key accelerates the connection.

KUTU PROFİL

BOX PROFILE

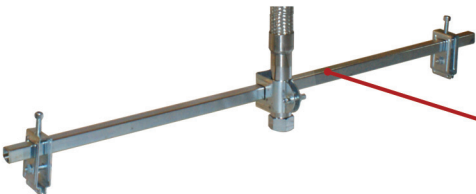

15 x 15 mm galvaniz kaplı kutu profil değişik boylarda yapılabilir.
The 15x15 mm galvanized box profile can be made in different sizes.

MONTAJ DETAYLARI

MOUNTING DETAILS

kayse®

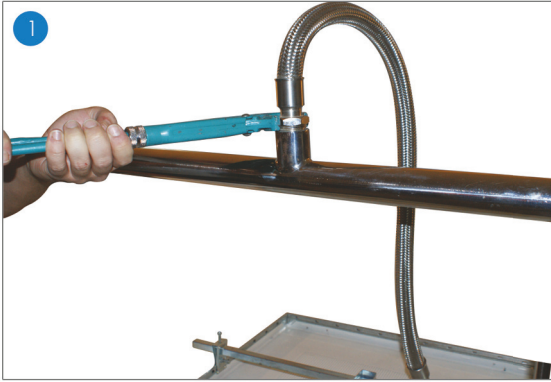

İsprinkler hortumunun 1" nipel kısmı yargın hattındaki mekanik T veya manşona anahtar yardımıyla sıkılır.
The 1" nipple of the sprinkler hose is secured to the mechanical T or clamping sleeve using a wrench.

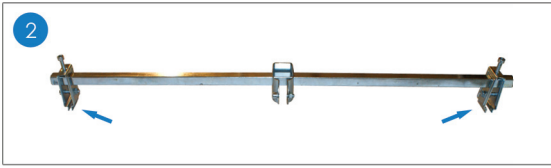

Şekil 2-A

Kutu profil, sağ-sol yan destekler ve orta kelepçe Şekil 2-A' da görüldüğü gibi birleştirilir

- Bu işlem esnasında yan destek üzerindeki tırnakların içeriye doğru olduğuna dikkat edilmelidir.
- Kutu profil; yan destekler üzerinde kenarlardan eşit miktarda çıkıntı kalacak şekilde durmalıdır.

Daha sonra Şekil 2-B' deki gibi bağlantı seti; tavanın 'T' profiline irtibatlandırılır.

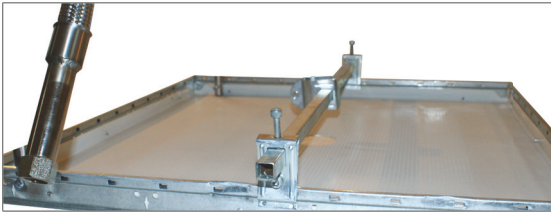

Şekil 2-B

The box profile is assembled by connecting the left and right supports and middle clamp as shown in Diagram 2-A.

- During this process, attention must be paid so that the connecting tabs on the sides of the side supports are facing inward.
- Box profile; must be positioned on the side supports with equal protrusion from both sides.

Next, the connection kit is connected to the 'T' profile on the ceiling as shown in Diagram 2-B.



Sprinkler hortumunun boşa kalan 1/2" kısmı orta kelepçeye şekildeki gibi geçirilir.

The 1/2" part of the sprinkler hose that is left outside is placed on the clamp as shown in the diagram.

MONTAJ DETAYLARI

MOUNTING DETAILS

kayse®

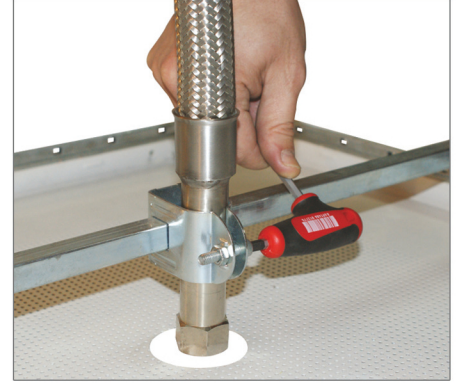
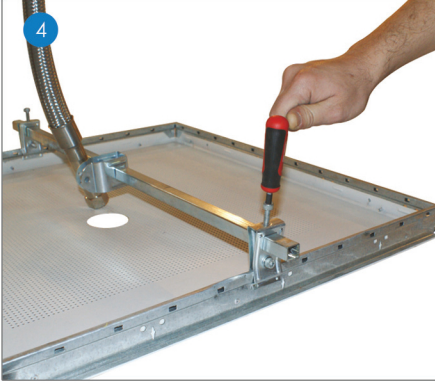

Sağ ve sol yan desteklerdeki civatalar ile orta kelepçe üzerindeki civata boşluğu alınacak şekilde sıkılır.

The nuts on the right and left supports are tightened in a way which will eliminate any slack between the nuts and the space between the middle clamp.

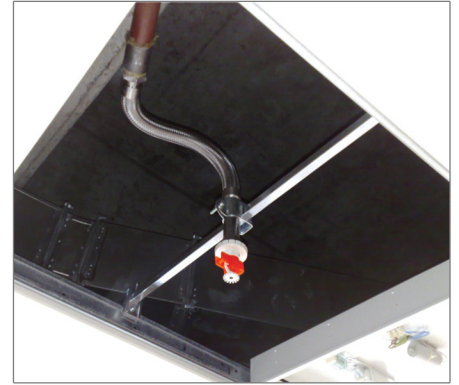
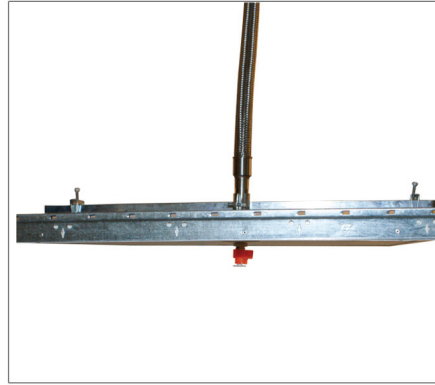
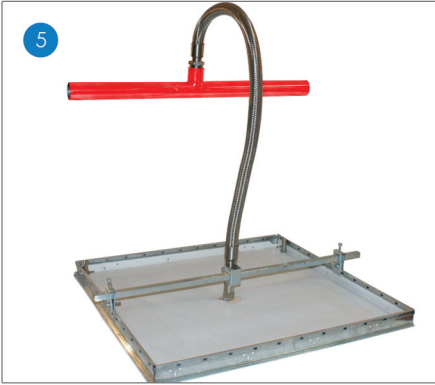

Son olarak sprinkler hortumu asma tavanın orta noktasındaki deliğe merkezlenir. Yan destekler üstten ve yandan tamamen sıkılır, hortumun uç kısmı tavan döşemesinin üst hizasında kalacak şekilde orta noktadaki kelepçeyle sabitlenir. Sprinkler nozulu takıldıktan sonra aksel kaçıklık varsa tekrar ayar yapılabilir.

Finally, the sprinkler hose is centered on the hole in the middle of the suspended ceiling. The side supports are tightened from top and sides completely; the end part of the hose is fixed with the central clamp as to remain above the headlining. After the sprinkler nozzle has been attached, a readjustment can be made if there is an eccentricity.

www.yanginsprinklerhortumu.com
www.sprinklerbaglantihortumu.com
www.kayse.com.tr



APPROVED
Sertifika No
3049835